

# syncro®

Opening a new chapter in  
PVC-U patio doors



**LAKESIDE  
LOCKS LTD**



**MADE & RECYCLED  
IN THE UK**

**eurocell®**

All together better

# INTRODUCING NEW SYNCRO SLIDING PATIO DOORS



**syncro**<sup>®</sup>

## NEW SLIDING PATIO DOORS

### **Introducing a new in-line system with even more benefits built in**

We're always looking to improve our products, though. So to keep in pace with customer demand, while staying in step with building regulations, the brand new Syncro system is here. Building on our unrivalled experience, Syncro isn't just our strongest and most secure patio door yet. It also offers better sustainability, design and performance – for you and your customers.

## A GREY REVOLUTION

The outstanding feature that makes Syncro so special, though, is its grey substrate option.

With a through-colour grey frame instead of just a surface foil, there's no sign of a white PVC-U core, even when you open the door.

It may seem like a small detail, but the all-grey look is a big thing with homeowners right now and many people are more than ready to pay a premium for it in PVC-U rather than choose the much more expensive aluminium option.

So make sure you're ready to supply everything they're looking for with the new Syncro sliding patio doors.



**NEW**



Syncro in Anthracite Grey

**NEW**

**GREY SUBSTRATE OPTION  
FOR THE CONSISTENT LOOK**

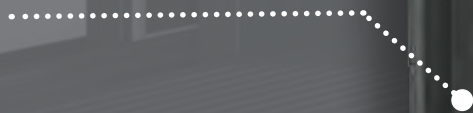



**syncro**<sup>®</sup>

## THE ALL NEW PATIO DOOR SYSTEM FROM EUROCELL

Eurocell leads the way in patio doors. In fact, we've long been the customer's choice when it comes to security, strength and performance with style.

### **Close to perfection in the patio door market**

Syncro is available to PAS24 standards, which means you can meet Document Q – the newest security regulations for patio doors. Plus, its improved strength, security and weather performance mean it also satisfies BS6375 as standard.

But that's just for starters. What makes Syncro really stand out are these brand new features that help it make a really impressive entrance on the marketplace:

- More sustainable with frame composition made up of at least 40% PCW (post-consumer waste)
- Better thermal efficiency with U-values as low as 1.3 for double glazed units and 1.0 for triple glazed
- Maximum width of 3.5m (2 pane) and a maximum sash width of 1750mm
- Triple as well as double glazing compatible for even better insulation
- Grey substrate for total coordination with modern designs
- Soft close option

# WHY CHOOSE SYNCRO?



**Width of up to  
3.5m available**



**Fast, accurate  
fabrication and  
installation**



**U-values  
as low as 1.0**

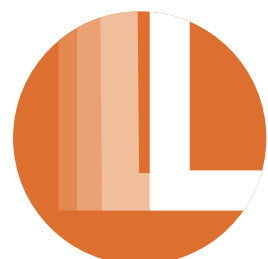

**Soft-close  
option**



**A choice of frame  
colours including  
grey substrate option**



**Triple glazing  
compatible**



**Delivery from  
6 working days**



**10-year  
guarantee for  
peace of mind**





# A WIDE SPECTRUM OF COLOURS

## COLOURS THAT MATCH YOUR PLANS

### Colours that match your plans

Like all Eurocell PVC-U products, the new Syncro system comes with an exact colour-match guarantee. That means the colour is precisely matched to all Eurocell window, door and conservatory roof products, creating a coordinated, consistent look across any property.

Syncro is normally manufactured with a white internal finish to maintain a bright, fresh interior, but some colours are available on both sides from stock.

Plus, Syncro doors are also available with a grey substrate for the look that's so much in demand at the moment.

### Up to 10-year guarantee

Syncro patio door profiles are guaranteed for ten years. Which means you and your customers enjoy all the reassurance of a robust, well-designed, precision-made product that's built to last.

## FRAME COLOURS FROM STOCK



**WHITE**  
White interior

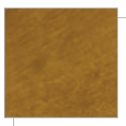

**GOLDEN OAK**  
White interior

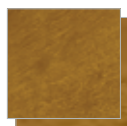

**GOLDEN OAK**  
Both sides



**ROSEWOOD**  
White interior



**ROSEWOOD**  
Both sides



**ANTHRACITE GREY**  
White interior

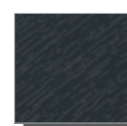

**ANTHRACITE GREY**  
(Both sides)  
Grey base

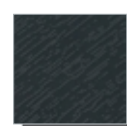

**ANTHRACITE GREY SMOOTH**  
Grey base

## FRAME COLOURS MADE TO ORDER



**ANTHRACITE GREY MATT**  
Grey base

**32 ADDITIONAL COLOURS AND SPECIFICATIONS ARE MADE TO ORDER ON EXTENDED LEAD TIMES**

Note: Grey base product features cool colours foil

## HANDLE COLOURS

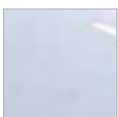

**WHITE**

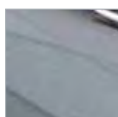

**HARDEX CHROME**

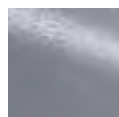

**HARDEX GRAPHITE**



# FEATURES & BENEFITS

## MARKET-LEADING PATIO DOOR

MADE FROM 40%  
**POST-CONSUMER  
WASTE**

U-VALUE .....  
**AS LOW AS 1.0**

PAS24 OPTIONS FOR.....  
**ULTIMATE SECURITY**

DOUBLE OR TRIPLE  
**GLAZING  
OPTIONS**

SOFT CLOSE .....  
**OPTION**

WIDTHS OF UP TO  
**3.5 METRES**  
(2 PANE)



Soft close eases door on closure to locking position

# TECHNICAL INFORMATION

## MINIMUM & MAXIMUM SIZES

### PATIO DOORS

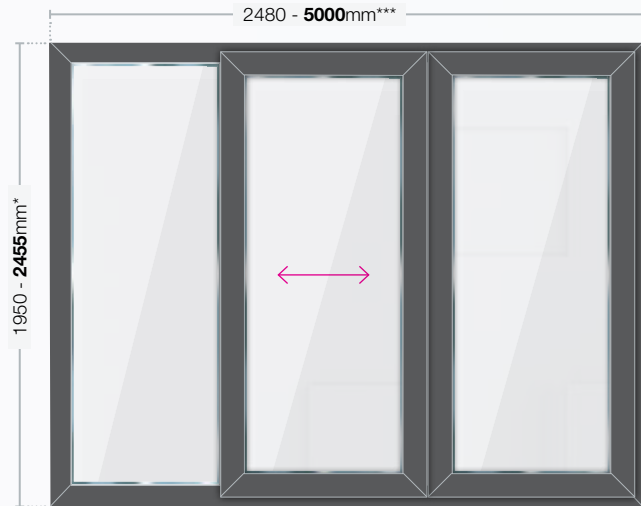
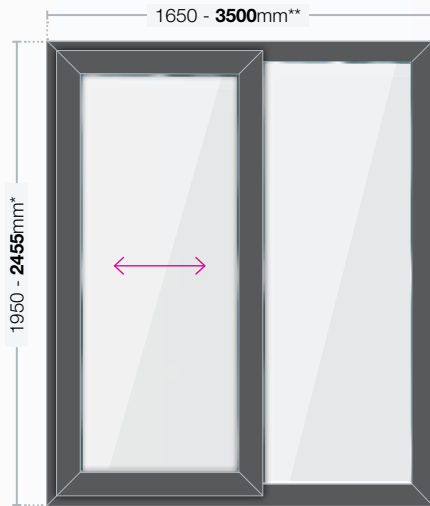

Sizes shown **do not** include cill.

Ensure suitable hardware is used that is capable of withstanding the sash weight.

All Sizes shown: MINIMUM - **MAXIMUM** in mm



**syncro**<sup>®</sup>  
Sliding Patio Doors



- \* Low threshold = 2400mm max height
- \*\* For 3201 - 3500mm door widths max door height = 2100mm
- \*\*\* For 4700 - 5000mm door widths max door height = 2100mm

# TECHNICAL INFORMATION

## SLIDING PATIO DOORS

### STANDARD THRESHOLD

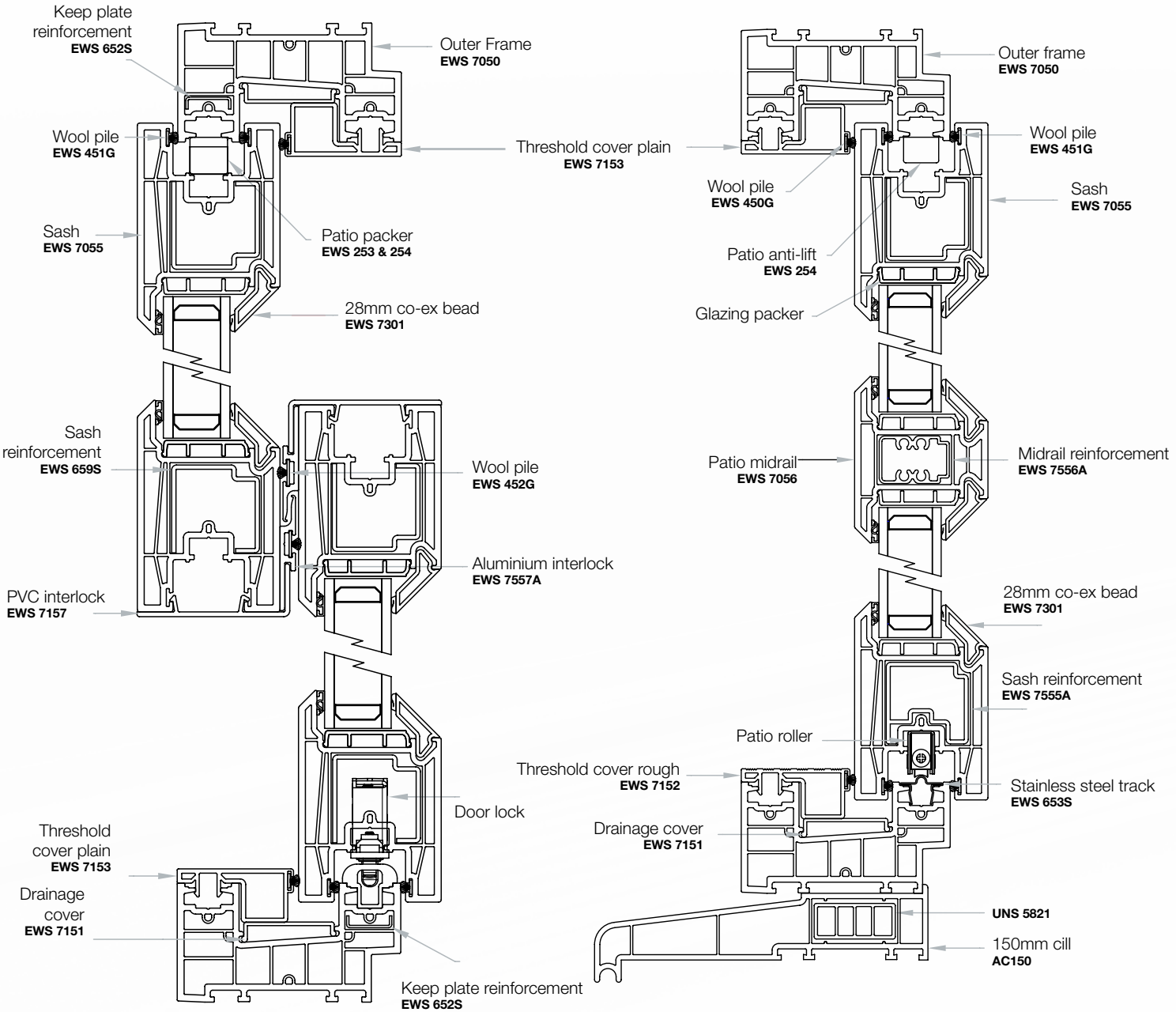

HORIZONTAL CROSS SECTION FOR 2 PANE STYLE

VERTICAL CROSS SECTION THROUGH SLIDING SASH

**syncro®**  
Sliding Patio Doors

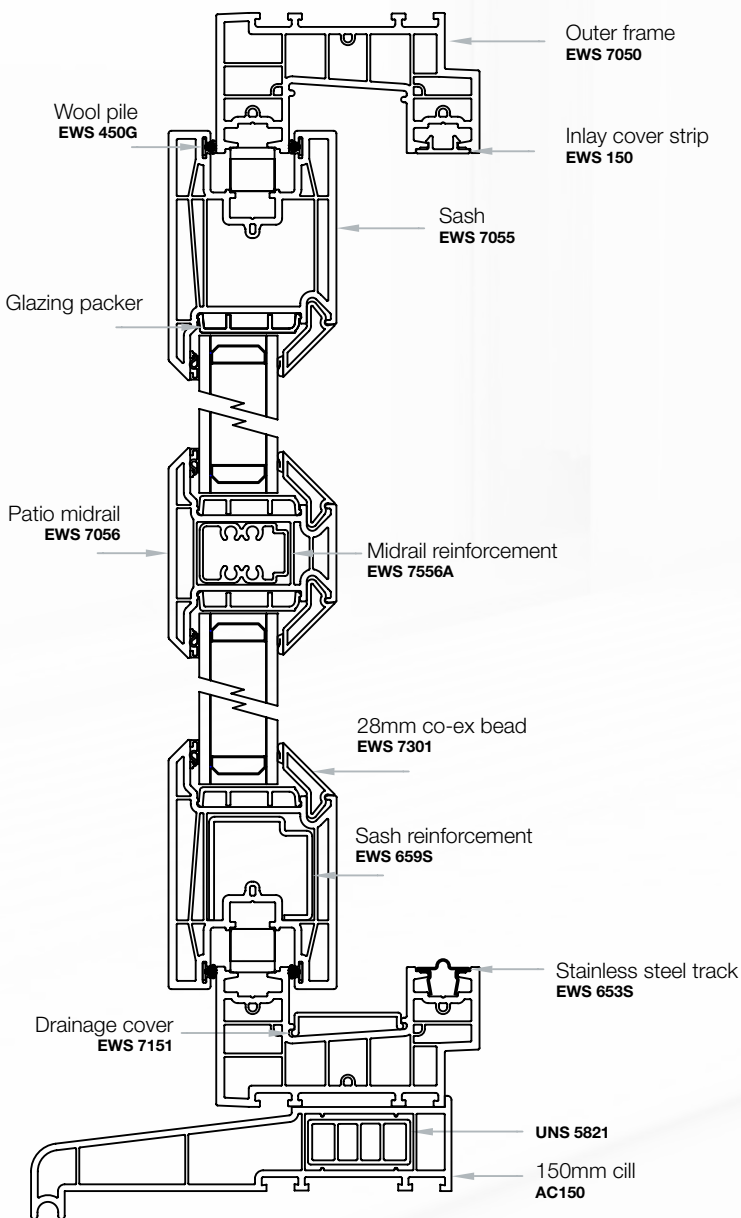

SLIDING SASH



FIXED SASH

VERTICAL CROSS SECTION THROUGH FIXED SASH



# TECHNICAL INFORMATION

## SLIDING PATIO DOORS

### LOW THRESHOLD

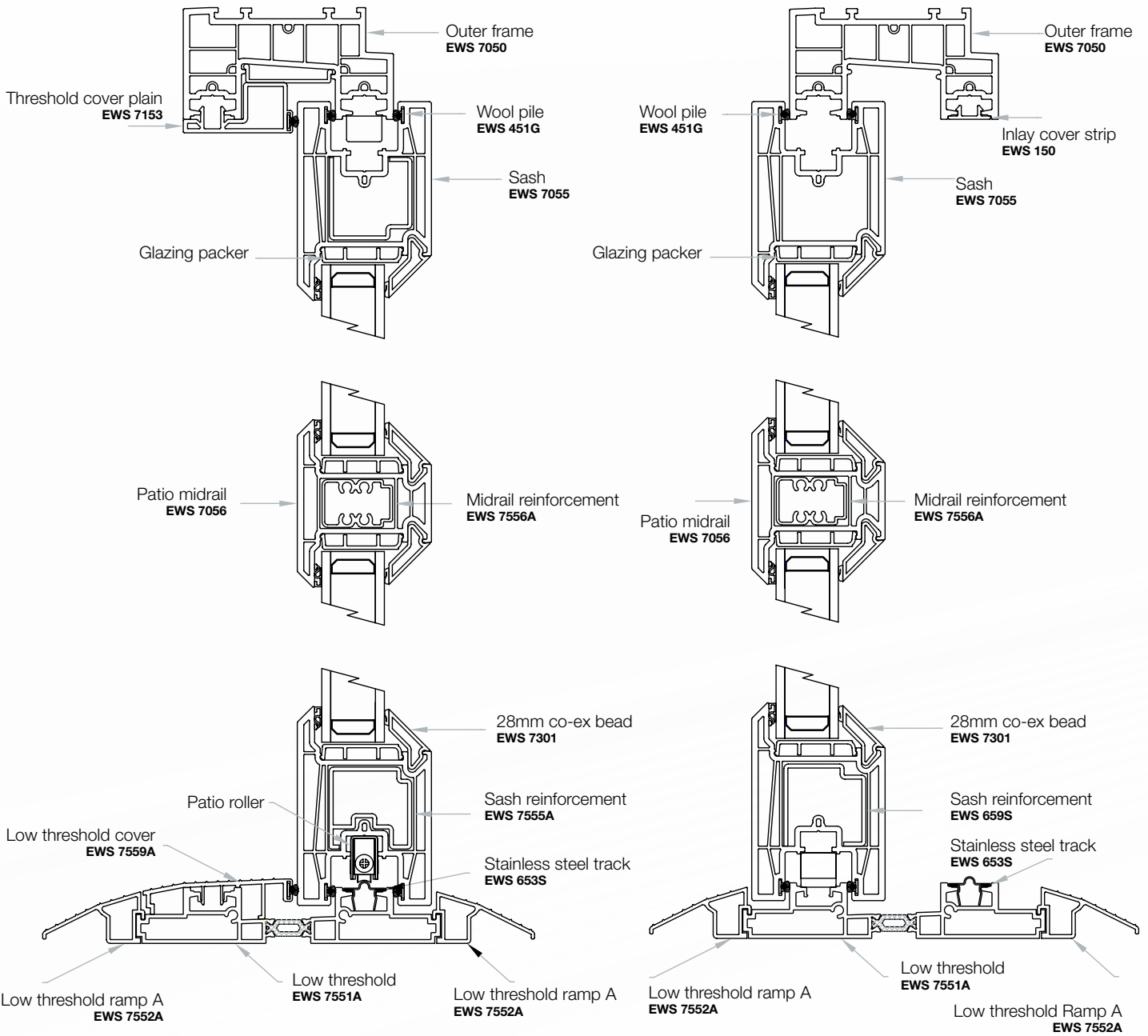

VERTICAL CROSS SECTION THROUGH SLIDING SASH WITH LOW THRESHOLD

VERTICAL CROSS SECTION THROUGH FIXED SASH WITH LOW THRESHOLD



Aluminium interlock



Soft close



Heavy duty roller option with  
four independent moving rollers



Thermally broken low threshold



Thicker steel with full reinforcement

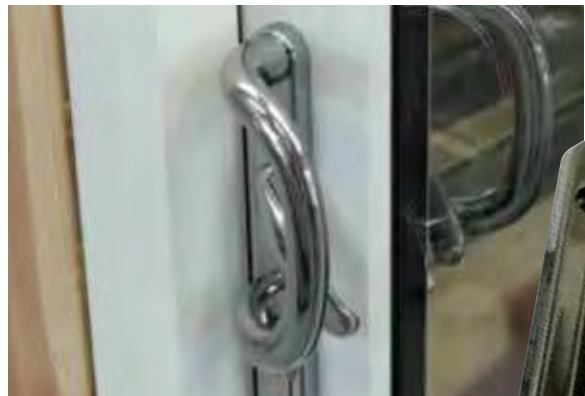

New hardware  
– Slimline handle option available



# TECHNICAL INFORMATION

## SYSTEM COMPONENTS

### PVC-U COMPONENTS

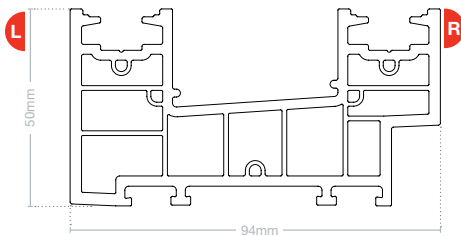

Outer frame  
EWS 7050

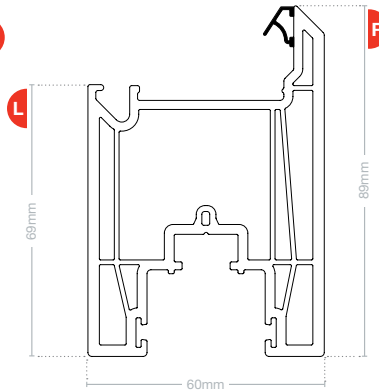

Sash  
EWS 7055

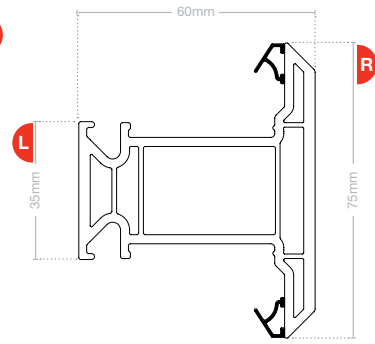

Midrail  
EWS 7056

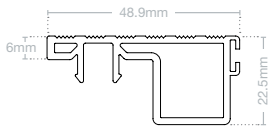

Threshold cover (rough)  
EWS 7152

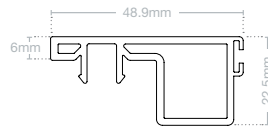

Threshold cover (plain)  
EWS 7153

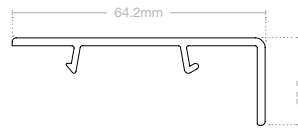

PVC Interlock  
EWS 7157

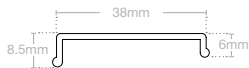

Drainage cover  
EWS 7151



Glazing packer  
EWS 7255



Inlay cover strip  
EWS 150

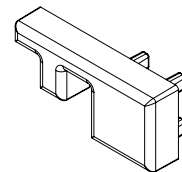

Crash stop  
EWS 7453

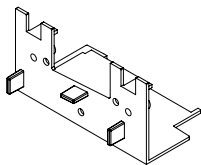

Frame mechanical joint moulding  
EWS 7254

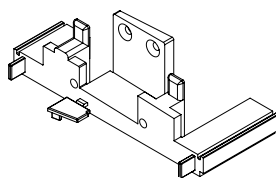

Low threshold moulding  
EWS 7252

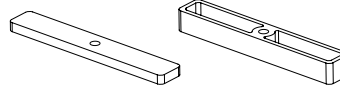

Fixed pane packer  
EWS 253

Anti-lift packer  
EWS 254

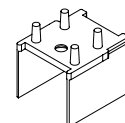

Meeting style end cap  
EWS 7253



36mm Bead  
EWS 7303



36mm Ovolo bead  
EWS 7313

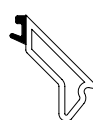

28mm Bead  
EWS 7301

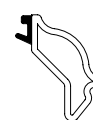

28mm Ovolo bead  
EWS 7312

KEY Left face **L** Right face **R**



**ALUMINIUM COMPONENTS**

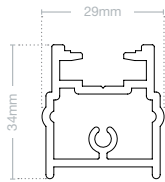

Meeting style  
**EWS 7553A**

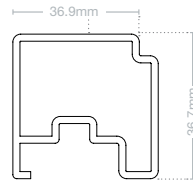

Sash reinforcing  
**EWS 7555A**

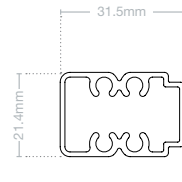

Midrail reinforcing  
**EWS 7556A**



PAS 24 Aluminium Interlock  
**EWS 7557A**



Standard aluminium Interlock  
**EWS 7560A**

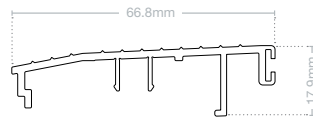

Threshold cover  
**EWS 7559A**

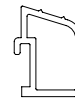

Low threshold ramp B  
**EWS 7558A**

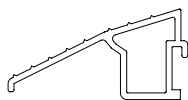

Low threshold Ramp A  
**EWS 7552A**

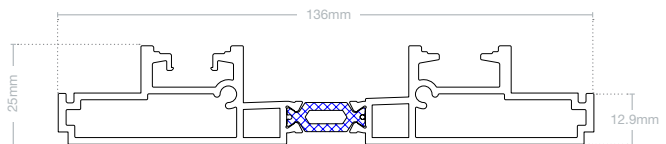

Low threshold  
**EWS 7551A**

**STEEL COMPONENTS**

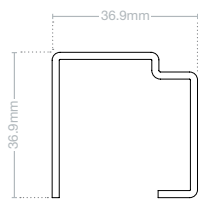

Heavy duty sash reinforcement  
**EWS 659S**  
**EWS 660S (Punched)**

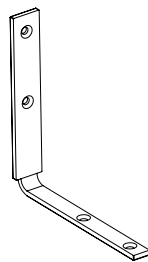

Fixed pane retention cleat  
**EWS 656S**

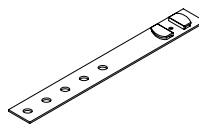

Fixing cleat  
**EWS 612S**

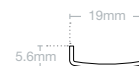

Keep plate reinforcement  
**EWS 652S**

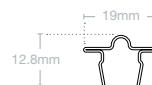

Stainless steel track  
**EWS 653S**

**GASKETS/SEALS**



Grey wool pile gasket  
(For use in threshold & interlock)  
**EWS 450G**



Black wool pile gasket  
(For use in sash only)  
**EWS 451G**



Wool pile gasket  
(For use in interlock only)  
**EWS 452G**

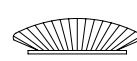

Mainframe drainage dam  
(For internal sliding patios only)  
**EWS 453G**



All together better

For more information about **syncro**® sliding patio door system from Eurocell, call our customer services team on **0800 988 3047**, or visit **eurocell.co.uk/syncro**

Eurocell plc, High View Road, Alfreton, Derbyshire DE55 2DT



**eurocell.co.uk**